

DKL



VELUX®



VAS 455300-2024-05

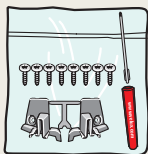
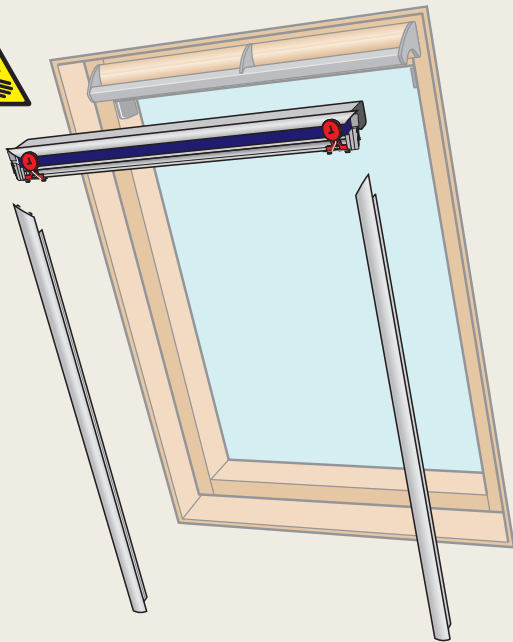

1

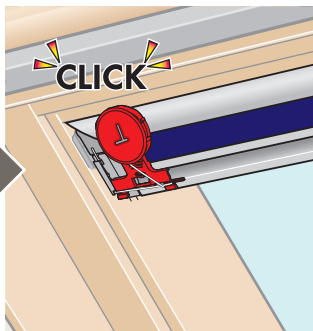
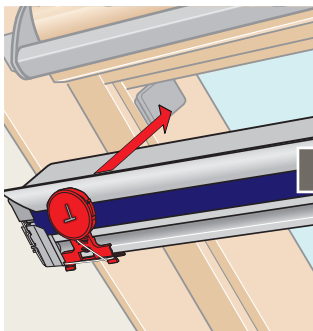
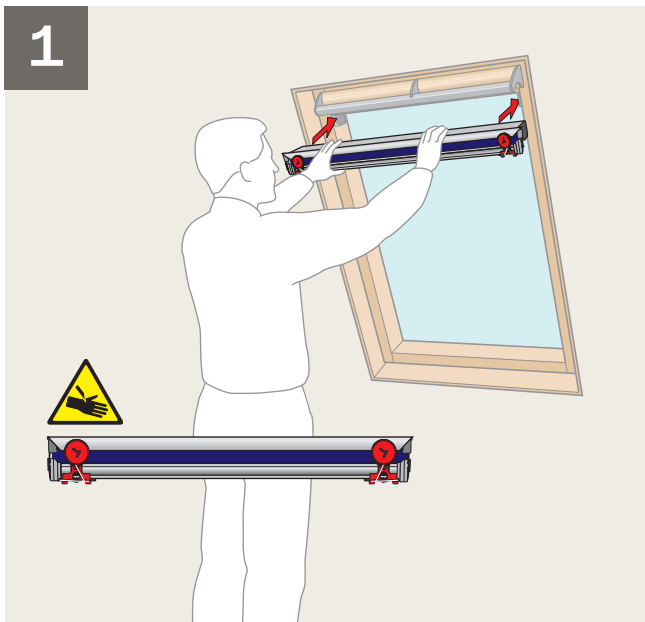

2

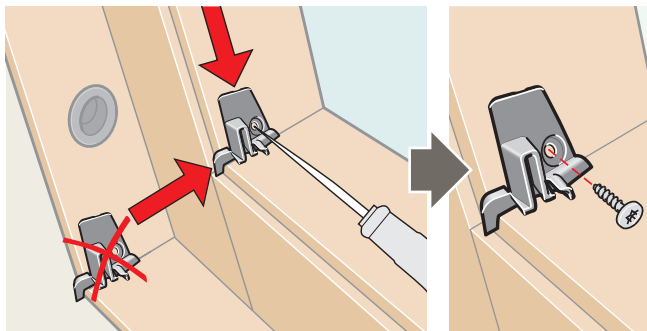
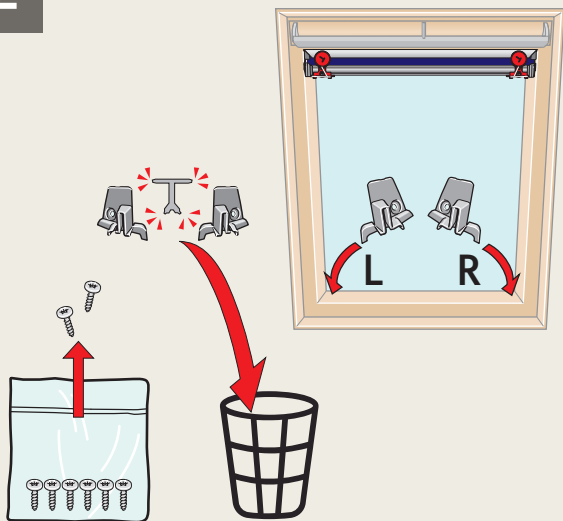

3

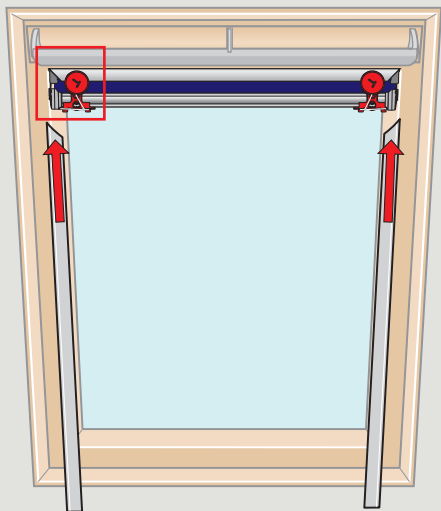
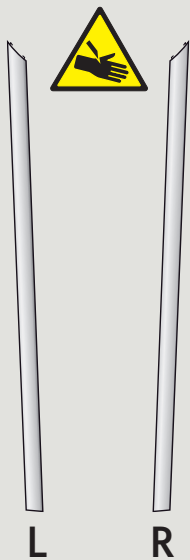

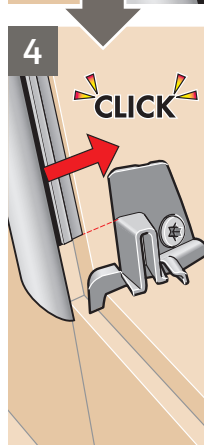
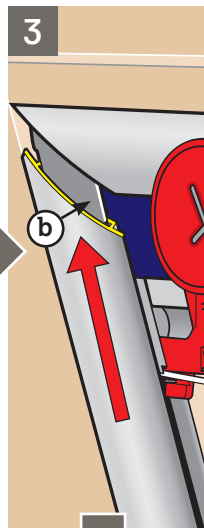
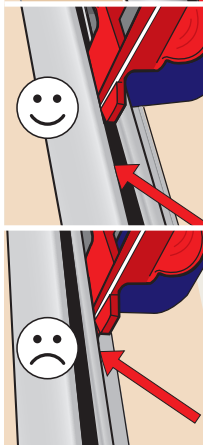
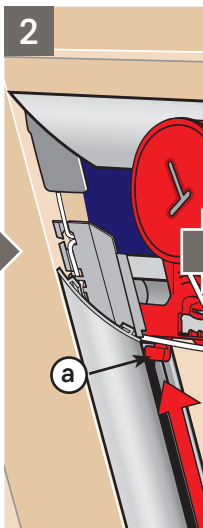
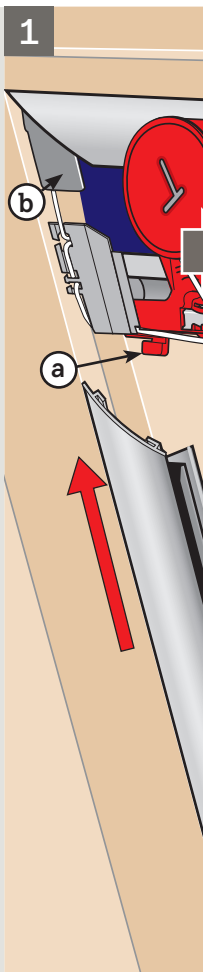

4

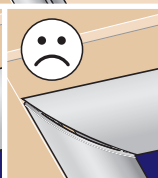
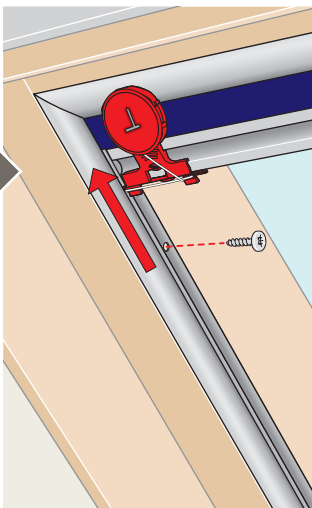
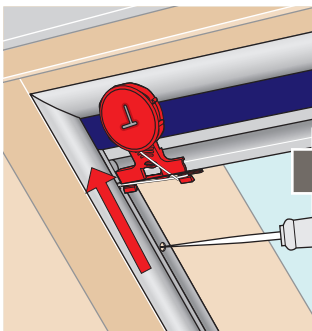
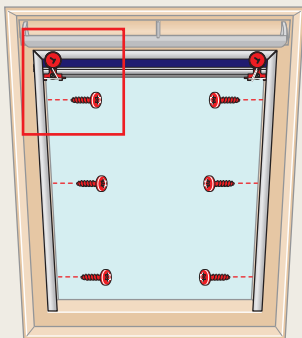
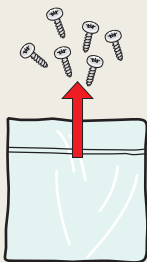

5

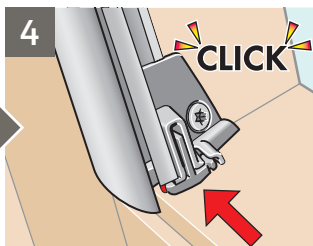
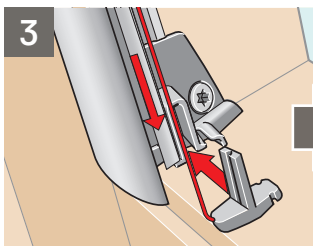
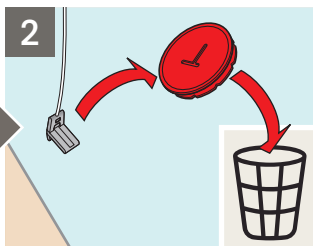
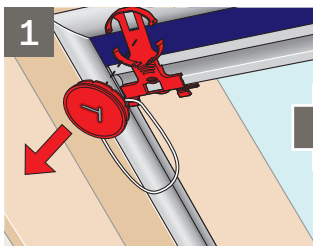
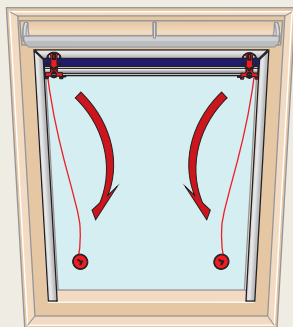

6

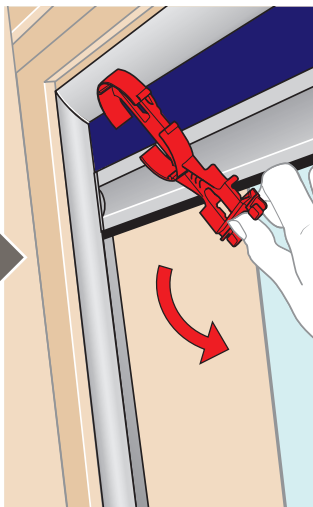
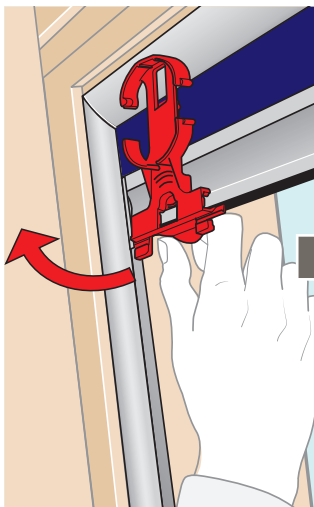
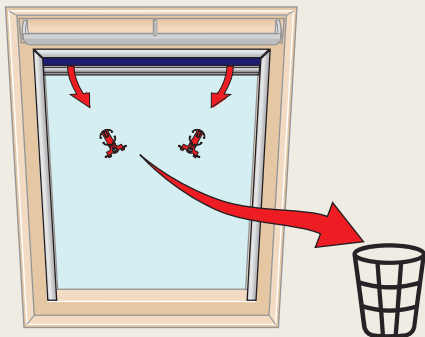

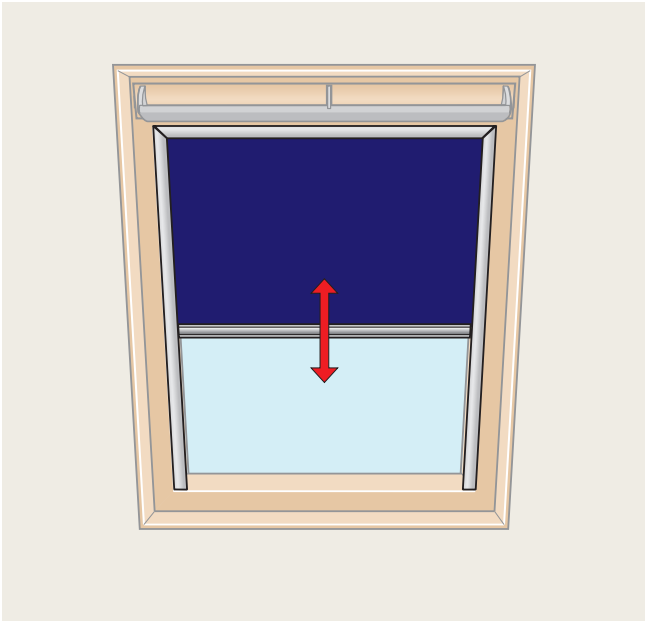

ENGLISH: Add an awning blind

- Reduce heat in the most effective way
- Weather resistant fabric for long lasting performance

DEUTSCH: Mit zusätzlicher Hitzeschutz-Markise kombinieren

- Effektive Hitzereduktion
- Wetterbeständiges Gewebe für lange Haltbarkeit

FRANÇAIS : Ajoutez un store extérieur pare-soleil

- Réduisez efficacement la chaleur
- Toile résistante aux intempéries

DANSK: Kombinér med et udvendigt solgardin

- Reducér varmen effektivt
- Holdbart og vejrbestandigt stof

ESPAÑOL: Añada un toldo exterior

- Reduzca el calor de la forma más eficaz
- Tejido altamente resistente para lograr un rendimiento duradero

ITALIANO: Aggiungi una tenda parasole esterna

- Riduci il calore nel modo più efficace
- Tessuto resistente alle intemperie per garantire prestazioni di lunga durata

NEDERLANDS: Voeg een buitenzonwering toe aan uw dakraam

- De meest effectieve manier om de hitte te reduceren
- Weerbestendig materiaal voor duurzaam gebruik

POLSKI: Dodaj markizę

- Zmniejsz stopień nagrzewania pomieszczeń w najbardziej skuteczny sposób
- Trwała i odporna na działanie czynników atmosferycznych tkanina

MAGYAR: Egészítse ki hővédő rolóval

- A lehető leghatékonyabban csökkentse a hőmérsékletet
- Időjárásálló szövet, mely hosszú távon biztosítja a tartósságot

**VELUX®**

- AR:** VELUX Export (VELUX A/S)
+ 45 4516 7885
- AT:** VELUX Österreich GmbH
02245/32 3 50
- AU:** VELUX Australia Pty. Ltd.
1300 859 856
- BA:** VELUX Bosna i Hercegovina d.o.o.
033/626 493, 626 494
- BE:** VELUX Belgium
(010) 42.09.09
- BG:** ВЕЛУКС България ЕООД
02/955 99 30
- CA:** VELUX Canada Inc.
1 800 88-VELUX (888-3589)
- CH:** VELUX Schweiz AG
062 289 44 45
- CL:** VELUX Export (VELUX A/S)
+ 45 4516 7885
- CN:** VELUX (CHINA) CO. LTD.
0316-607 27 27
- CZ:** VELUX Česká republika, s.r.o.
531 015 511
- DE:** VELUX Deutschland GmbH
www.velux.de/kontakt
- DK:** VELUX Danmark A/S
45 16 45 16
- EE:** VELUX Eesti OÜ
621 7790
- ES:** VELUX Spain, S.A.U.
91 509 71 00
- FI:** VELUX Suomi Oy
0207 290 800
- FR:** VELUX France
0806 80 15 15
Service gratuit + prix appel
- GB:** VELUX Company Ltd.
01592 778 225
- HR:** VELUX Hrvatska d.o.o.
01/5555 444
- HU:** VELUX Magyarország Kft.
(06/1) 436-0601
- IE:** VELUX Company Ltd.
01 848 8775
- IT:** VELUX Italia s.p.a.
045/6173666
- JP:** VELUX-Japan Ltd.
0570-00-8141
- KR:** VELUX Export (VELUX A/S)
+ 45 4516 7885
- LT:** VELUX Lietuva, UAB
(85) 270 91 01
- LV:** VELUX Latvia SIA
67 27 77 33
- NL:** VELUX Nederland B.V.
030 - 6 629 629
- NO:** VELUX Norge AS
22 51 06 00
- NZ:** VELUX New Zealand Ltd.
0800 650 445
- PL:** VELUX Polska Sp. z o.o.
(022) 33 77 000 / 33 77 070
- PT:** VELUX Portugal, Lda
21 880 00 60
- RO:** VELUX România S.R.L.
0268-402740
- RS:** VELUX Srbija d.o.o.
011 20 57 500
- SE:** VELUX Svenska AB
042/20 83 80
- SI:** VELUX Slovenija d.o.o.
01 724 68 68
- SK:** VELUX Slovensko, s.r.o.
(02) 33 000 555
- TR:** VELUX Çati Pencereleri
Ticaret Limited Şirketi
0 216 302 54 10
- UA:** ТОВ "ВЕЛЮКС Україна"
(044) 2916070
- US:** VELUX America LLC
1-800-88-VELUX

www.velux.com